

FEATURES

- The preferred pump frame in the car wash self-service industry
- Forged brass manifold with an exclusive lifetime warranty
- Large-capacity, die-cast, anodized aluminum oil-bath crankcase
- Over-sized connecting rods for maximum life
- Heavy-duty tapered roller bearing.
- Solid ceramic plungers with continuously lubricated packings
- Unitized stainless steel inlet and discharge valves
- Available in left-handed “L” version



SPECIFICATIONS

Pump Model	CW3040
Maximum Volume	5.0 GPM
Max. Discharge Pressure	3000 PSI
Maximum Pump Speed	1250 RPM
Maximum Inlet Pressure	125 PSI
Bore	.787 in. / 20 mm
Stroke	.630 in. / 16 mm
Crankcase Oil Capacity	40.6 oz.
Maximum Fluid Temp.	165°F
Inlet Port Thread	1/2-14 BSPP-F
Discharge Port Thread	3/8-19 BSPP-F
Shaft Diameter.	.945 in. / 24 mm
Weight	32 lbs.
Dimensions	12.2 x 9.2 x 7.2 in.

DIMENSIONAL DRAWING

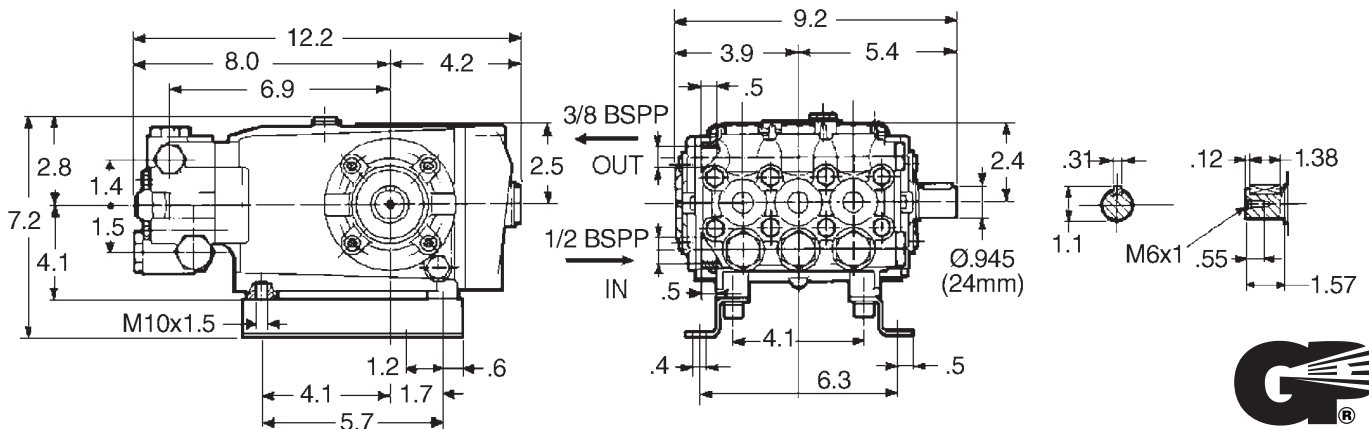

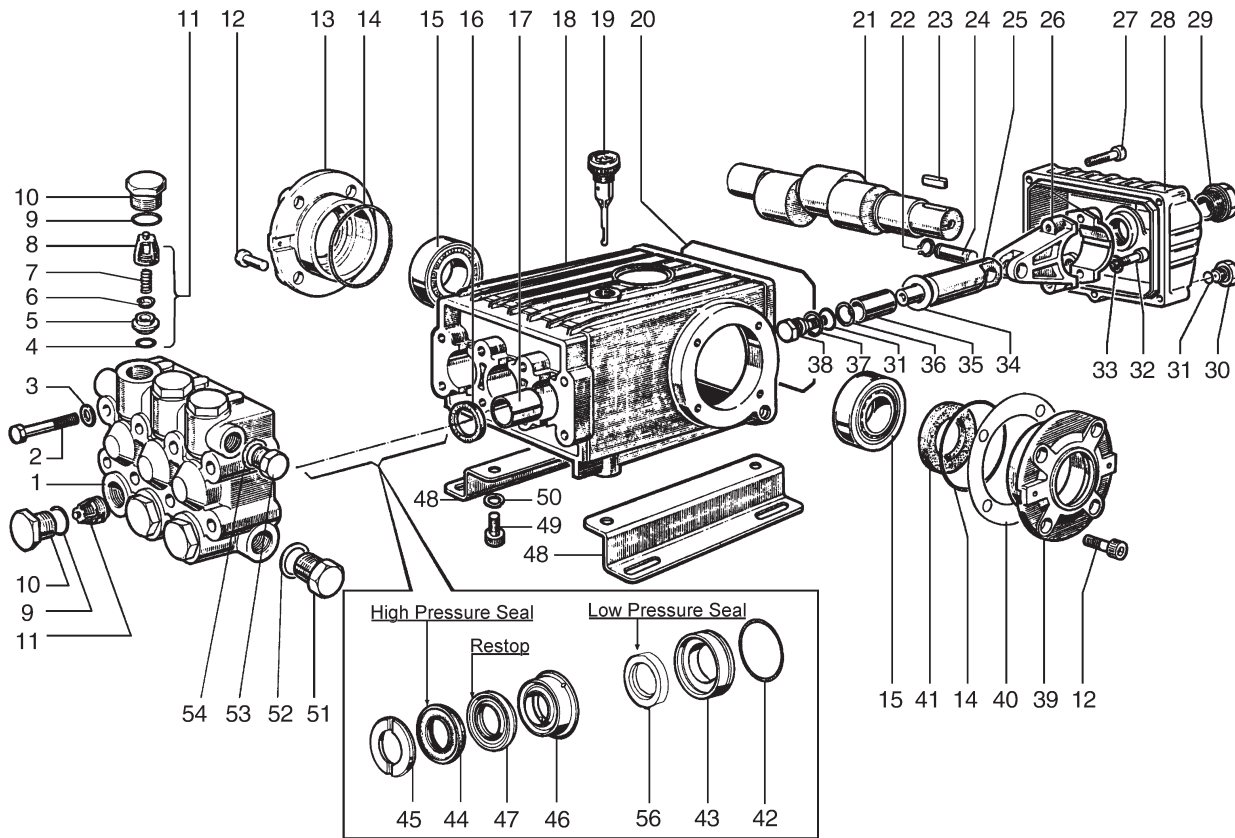

PARTS LIST

ITEM PART NO.	DESCRIPTION	QTY.	ITEM PART NO.	DESCRIPTION	QTY.	ITEM PART NO.	DESCRIPTION	QTY.
1. 47120841	Manifold	1	21. 47021735	Crankshaft		41. 90164800	Seal, Oil	2
2. 99320600	Screw, M8 x 70	8	22. 90055700	Ring, Snap, M12	6	42. 90361600	O-Ring, 1.364 x .070	3
3. 96702000	Washer, M8.4	8	23. 91489000	Key	1	43. 47080970	Retainer, Seal, Low Press.	3
4. 701115	O-Ring, .674 x .103	6	24. 97738000	Pin, Wrist	3	44. 90270500	Seal, High Pressure	3
5. 36200366	Seat, Valve	6	25. 47050454	Guide, Piston	3	45. 47100051	Ring, Head, M20	3
6. 36200176	Plate, Valve	6	26. 47030001	Rod, Connecting	3	46. 47216970	Ring, Intermed., M20	3
7. 94737600	Spring	6	27. 99183700	Screw, M6 x 14	5	47. 90270400	Ring, Restop	3
8. 36200251	Guide, Valve	6	28. 47160422	Cover, Crankcase		48. 47200074	Rail, Pump	2
9. 701002	O-Ring, .797 x .103	6	29. 97596800	Oil Indicator	1	49. 99364400	Screw, M10 x 18	4
10. 98222000	Cap, M24	6	30. 98204100	Cap	1	50. 96710600	Washer, M10.2	4
11. 36703201	Valve Assembly	6	31. 701013	O-Ring, .426 x .070	4	51. 98217600	Cap	1
12. 99303900	Screw, M8 x 16	8	32. 99309900	Screw, M8 x 35	6	52. 96751400	Washer, M21.5	1
13. 47150122	Cover, Crankcase	1	33. 96701400	Washer, M8.4	6	53. 98210000	Cap	1
14. 90391300	O-Ring, 2.68 x .103	2	34. 96728600	Washer, M14	3	54. 96738000	Washer, M17.5	1
15. 91837500	Bearing, Roller	2	35. 47040409	Plunger, (20 mm)	3	56. 90269400	Seal, Low Pressure	3
16. 90162500	Seal, Oil	3	36. 660067	Ring, Back-up	3			
17. 90912600	Bushing	3	37. 96728000	Washer, M14	3			
18. 47010422	Crankcase	1	38. 47219566	Screw, Plunger	3			
19. 98210600	Oil Dip Stick	1	39. 47150022	Cover, Crankcase	2			
20. 47211984	Cover, Gasket	1	40. 97567800	Shim	2			
						Optional		
						190160	Rail & Coupler Kit (310)	1
						190161	Rail & Coupler Kit (530)	1

REPAIR KITS

KIT NO.	K01	K02	K03	K04	K06	K07	K71	K969	K9101A	K910
ITEM NO.s INCLUDED IN KIT	11	16	41	9, 10	31, 34, 36, 37, 38	45	46, 47	44, 47, 56	42, 43, 44, 45, 46, 47, 56	42, 43, 56
NUMBER OF ASSEMBLIES IN KIT	6	3	2	6	3	6	3	3	1	3
NUMBER OF CYLINDERS KIT WILL SERVICE	6	3	-	3	3	3	3	3	1	3

TORQUE SPECS*

Position	Ft.-lbs.
2	22.1
10	73.7
12	14.7
27	7.3
29	13.2
30	14.7
32	14.7
38	14.7
49	29.4
51	29.4

*Decrease torque by 20% if threads are lubricated.

